

BREATHE HEALTHIER®  
**GeneralAire®**

**PRODUCT  
CATALOGUE  
2024**

**VALID FROM MARCH 1ST 2024 - MARCH 31ST 2025**

# PRODUCT TOWER CO-OP PROGRAM

Introducing our brand new GeneralAire Product Tower, showcasing our top IAQ products including humidifiers, dehumidifiers, air cleaners and UV air purifiers.

## Products Included:

- GF4400A Fan Assisted Humidifier
- GF3200DMM Bypass Humidifier
- GF3200PFT Pulse Flow Through Humidifier
- GFMAC1400-11 Air Cleaner
- GF1625-11 Air Cleaner
- DH75 Dehumidifier
- SF2018 UVC Air Purifier
- GFX4 Digital Humidistat
- GFMHX3 Manual Humidistat

FRONT A



SIDE A



SIDE B



FRONT B

## CONTACT US

 [sales@generalaireiaq.ca](mailto:sales@generalaireiaq.ca)

 (416) 757-3691

CHECK OUT A 360  
VIEW OF OUR  
PRODUCT TOWER



<b>1</b>	<b>HUMIDIFIERS</b>	
	All Humidifiers Quicklook .....	1-2
	Vapor Pads .....	3
	Accessories .....	4
	GF4400A .....	5
	GF3200DMM/DMD .....	6
	GF4200DMM/DMD .....	7
	GF1042DMM/DMD .....	8
	GF5500 .....	9
	DSRDAH .....	10
	GF3200PFT .....	11
	GF4200PFT .....	12
	GF1099LHS .....	13
	GF1137L .....	14
	Legacy Elite Steam Parts .....	15
<b>2</b>	<b>DEHUMIDIFIERS</b>	
	Dehumidifiers .....	16
<b>3</b>	<b>AIR CLEANERS</b>	
	MAC & GeneralAire Air Cleaners .....	17
	HEPA, TERSUS & AC Models .....	18
<b>4</b>	<b>SECONDWIND</b>	
	Residential Air Purifiers .....	19
	Commercial Air Purifiers .....	20
<b>5</b>	<b>GENERAL &amp; GARBER OIL FILTERS</b>	
	General Oil Filters .....	21
	General Oil Accessories .....	22
	Garber Oil Filters .....	23
<b>6</b>	<b>TJERNLUND</b>	
	Specific Parts Quicklook .....	24-25
	In-Line Inducers .....	26-27
	Side Wall Vent Systems .....	28-29
	Power Venters .....	30
	Commercial Power Venters .....	31
	Duct Boosters .....	32
	Combustion Equipment & Accessory Control .....	33
<b>7</b>	<b>MASTERCRAFT</b>	
	Sootmasters .....	34
	More Sootmasters Parts .....	35
<b>8</b>	<b>SUPERIOR</b>	
	Smoke Generators .....	36

## Confidential Distributors List Prices

# HUMIDIFIERS



### GF4400A FAN ASSIST HUMIDIFIER

The 4400A uses a very quiet cross-flow fan rated at 48dB, a 25% reduction in noise versus the rotary blade 1000. Uses "1/2" Push-On Valve with Shutoff in Place of Saddle Valve.



Product Code	Description	Standard Package	Standard Weight (KG)
GF4400A	Fan-Assist Evaporative Humidifier	1	4.53
GFGA35	Replacement Vapor Pad	1	0.5



### GF3200 EVAPORATIVE HUMIDIFIER

Flow through humidifier with MXH3 or GFX4 stat. Designed for lower plenum temperatures, fits tight spaces, new stainless steel water supply tube, smaller low profile cover, left or right by pass installation, water supply tubing for hot or cold water.

Product Code	Description	Standard Package	Standard Weight (KG)
GF3200DMM	Deluxe Flow Thru Humidifier w/ MXH3 Manual Humidistat	1	7
GF3200DMD	Deluxe Flow Thru Humidifier w/ GFX4 Digital Humidistat	1	7
GFGA10	Replacement Vapor Pad	1	0.5



### GF4200 EVAPORATIVE HUMIDIFIER

Flow through humidifier with MXH3 or GFX4 stat. Designed for lower plenum temperatures, fits tight spaces, new stainless steel water supply tube, smaller low profile cover, left or right by pass installation, water supply tubing for hot or cold water.

Product Code	Description	Standard Package	Standard Weight (KG)
GF4200DMM	Deluxe Flow Thru Humidifier w/ MXH3 Manual Humidistat	1	8
GF4200DMD	Deluxe Flow Thru Humidifier w/ GFX4 Digital Humidistat	1	8
GFGA35	Replacement Vapor Pad	1	0.5



### GF1042 EVAPORATIVE HUMIDIFIER

Flow through bypass humidifier with patented water distribution system. Includes integral bypass damper, wall/duct humidistat, 24v transformer, 6" plenum collar, 15' drain hose, and brass fittings. The Deluxe includes a cold water installation kit.

Product Code	Description	Standard Package	Standard Weight (KG)
GF1042DMM	Deluxe Flow Thru Humidifier w/ MXH3 Manual Humidistat	1	6.2
GF1042DMD	Deluxe Flow Thru Humidifier w/ GFX4 Digital Humidistat	1	6.2
GF990-13	Replacement Vapor Pad	1	1.0



### GF1099LHS EVAPORATIVE HUMIDIFIER

Flow thru by pass drain type humidifier with patented Kinetic Flo® through water distribution system for maximum evaporative performance. Humidity control damper standard with 7" installation ring, solenoid valve, transformer and MXH3 humidistat

Product Code	Description	Standard Package	Standard Weight (KG)
GF1099LHS	Flow Through Bypass Humidifier w/MXH3 Manual Humidistat	1	8.6
GFGA23	Replacement Vapor Pad	1	0.5



### GF5500 STEAM HUMIDIFIER

Steam Humidifier with GFX4 stat. Duct mount kit included. Produces up to 28.5 gallons per day.



Product Code	Description	Standard Package	Standard Weight (KG)
GF5500	Steam Humidifier up to 5500 sq. ft.	1	6.81
GF55	Replacement Steam Cylinder	1	1.07



### GF1137L FAN POWERED HUMIDIFIER

Drain type fan power humidifier for warm air plenum installations. Built in isolation relay feature provides 24V secondary voltage for control of fan motor. Includes solenoid valve, 110V power cord, 15' of 5/8" dia drain hose, valve & humidistat

Product Code	Description	Standard Package	Standard Weight (KG)
GF1137L	Fan Powered Flow Through Humidifier	1	8.12
GF990-13	Replacement Vapor Pad	1	1.0

Prices shown are based on carton quantities. 5% surcharge for broken cartons. Effective July 1st, 2023, our minimum Order Value before H.S.T. is \$250. Replacement parts not included. A surcharge of \$25 on all orders under this minimum will be applied. All prices are subject to change without notice.





## Confidential Distributors List Prices

### HUMIDIFIERS



#### DSRDAH ROTARY DISC HUMIDIFIER

The Rotary Disc evaporative disc wheel contains 42 polycarbonate discs creating an unprecedented 15 square feet of surface area. Due to the large contact area between the water and airflow, the Rotary Disc design produces humidity even with room temperature (recirculation) air and is an ideal by-pass humidifier for Heat Pump applications.



Product Code	Description	Standard Package	Standard Weight (KG)
DSRDAH	Rotary Disc Humidifier	1	8.6
DSAF15	Autoflush Kit	1	3.0



#### GF3200PFT PULSE FLOW THROUGH HUMIDIFIER

Patented electronic water flow control reduces demand for water by up to 88% compared to ordinary flow-through humidifiers. When in operation, the water supply solenoid valve is pulsed on for approximately 4 seconds, sufficient time to soak the entire evaporative pad. Humidifies up to 3200 sq. ft.

Product Code	Description	Standard Package	Standard Weight (KG)
GF3200PFT	Pulse Flow Thru with Patented Controller Humidifier	1	8
DPDS00200	Replacement Vapor Pad	1	0.5
DPHSA220	Solenoid (Water Hammer Assembly)	1	0.5



#### GF4200PFT PULSE FLOW THROUGH HUMIDIFIER

Patented electronic water flow control reduces demand for water by up to 88% compared to ordinary flow-through humidifiers. When in operation, the water supply solenoid valve is pulsed on for approximately 4 seconds, sufficient time to soak the entire evaporative pad. Humidifies up to 4200 sq. ft.

Product Code	Description	Standard Package	Standard Weight (KG)
GF4200PFT	Pulse Flow Thru with Patented Controller Humidifier	1	8
GFGA900	Replacement Vapor Pad	1	0.5
DPHSA220	Solenoid (Water Hammer Assembly)	1	0.5

Prices shown are based on carton quantities. 5% surcharge for broken cartons. Effective July 1st, 2023, our minimum Order Value before H.S.T. is \$250. Replacement parts not included. A surcharge of \$25 on all orders under this minimum will be applied. All prices are subject to change without notice.



**Confidential Distributors List Prices**

**HUMIDIFIER VAPOR PADS**



Product Code	Models Fit For
GFGA10	GeneralAire: GF3200DMM & GF3200DMD AprilAire: 110, 220, 500, 500A, 500M, 550, 550A & 558 Honeywell: HE100, HE150, HE220, HE225, HE240, & HE280
GFGA12	AprilAire: 112, 136, 224, 440, 445 & 445A
GFGA23	GeneralAire: GF1099LHS & 950
GFGA35	GeneralAire: GF4200DMM, GF4200DMD & GF4400A AprilAire: 350, 360, 560, 568, 600, 600A, 600M, 700, 700A, 700M, 760, 768 Honeywell: HE260, HE265, HE360, HE365
GFGA570	GeneralAire: GF570DMM, GF570DMD & GF570WSC
GFGA900 (Previously GFGA19)	GeneralAire: GF900DMM, GF4200PFT, GF1000LHM, GF900WSC & GF1000LHD
GF990-13	GeneralAire: GF1040L, GF1042DMM, GF1042DMD, GF1042LH, GF1042WSC, GF1137L & SL16
GF1099-20	General Aire: GF1099LH (For Models Made before August 2008)
DPDS00200	GeneralAire: GF3200PFT
GF81-15	GeneralAire: Model 81 Skuttle: 90S
GF727-12	GeneralAire: Model 747L & 727

Prices shown are based on carton quantities. 5% surcharge for broken cartons. Effective July 1st, 2023, our minimum Order Value before H.S.T. is \$250. Replacement parts not included. A surcharge of \$25 on all orders under this minimum will be applied. All prices are subject to change without notice.







## Confidential Distributors List Prices

# HUMIDIFIER ACCESSORIES & REPLACEMENT PARTS





### HUMIDISTATS

Image	Product Code	Description
	GFX4	Digital Humidistat with Furnace Blower Controller
	GFMHX3	Manual Humidistat. Wall or Duct Mount
<b>NEW</b> 	GFX4-1	Outdoor Sensor for GFX4





### SOLENOID VALVES

Image	Product Code	Description
	GF4200-05	Solenoid Valve for 3200DMM/4200DMM
	GF990-53	Solenoid Valve 24V for models 1042 & 1137. Includes fittings
	DPHSA220	Solenoid Valve with Water Hammer for GF-3200PFT & GF-4200PFT
	GFGA4040	Solenoid Valve 24V for Elite Series Humidifiers. 1099LHS/570/900 Humidifiers. Also fits Aprilaire models 550, 560,600
	GF16-20	Solenoid Valve for SL16
	GF109942	Solenoid Valve for Model 1099LH (OLDER MODEL)
	GF4400-05	Solenoid Valve

### ACCESSORIES

Image	Product Code	Description
	GFAP2	Aquapro Digital Water Tester
	GF12500	Fan Sensing Switch
	GFG98	Indoor Digital Humidity Temperature Gauge. Wall mount or table top positioning
	GFG99	Filter Media Indicator (for use with residential & light commercial mechanical filter system)

### OTHER PARTS

Image	Product Code	Description
	DPDS00325	Quick Connect Tee valve w/Shut Off (Replaces GP81-51SPV Saddle Valve Assembly Self Tapping)
	GFGA50 GFGA51	24V Current Sensing Relay / 120V Current Sensing Relay
	GP81-45	24V Transformer
	GF81-53	Float Valve assembly for Model 65 & 81
<b>NEW</b> 	GP4200-38	PEX Tubing Kit (For GF3200DMM, GF4200DMM & GF4400A) *Optional for All Other Humidifier Models*

Prices shown are based on carton quantities. 5% surcharge for broken cartons. Effective July 1st, 2023, our minimum Order Value before H.S.T. is \$250. Replacement parts not included. A surcharge of \$25 on all orders under this minimum will be applied. All prices are subject to change without notice.

## Confidential Distributors List Prices

# GF4400A FAN ASSIST HUMIDIFIER

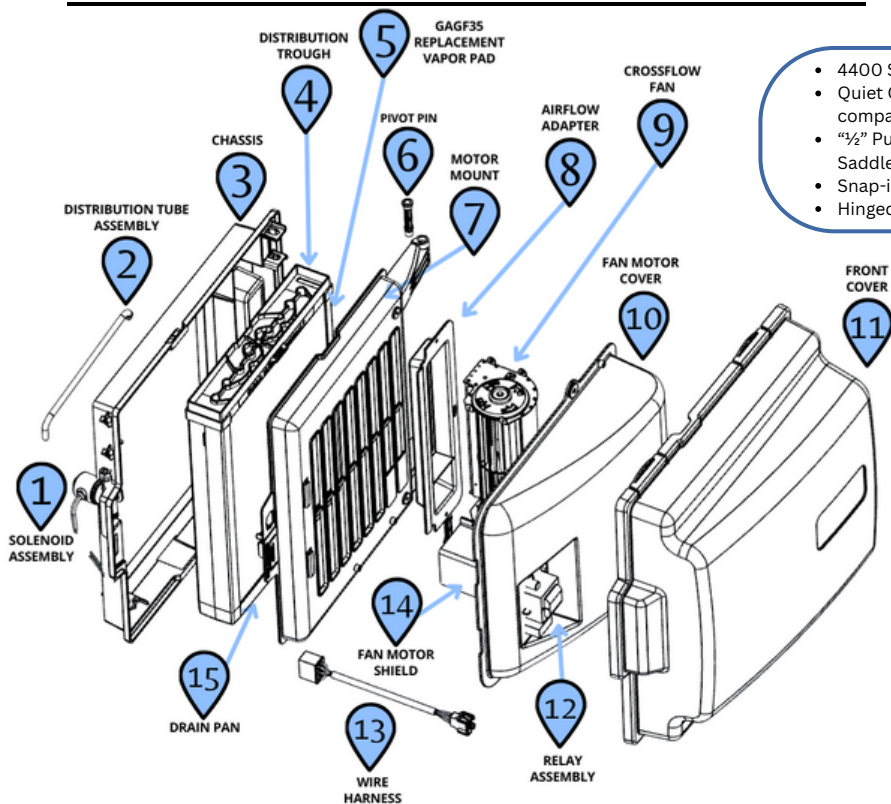

- 4400 Square Foot Coverage, 19 GPD
- Quiet Cross-Flow Fan, Low Decibel Sound compared to Axial Fan
- "½" Push-On Valve with Shutoff in Place of Saddle Valve
- Snap-in-Place, Easy-Lift-Off Cover
- Hinged Door

Diagram Number	Product Code	Description
N/A	GF4400A	Fan-Assist Evaporative Humidifier
1	GF4400-05	Solenoid Valve
2	GF4200-21	Distribution Tube Assembly
3	GF4400-01	Chassis
4	GF4200-15	Distribution Trough
5	GFGA35	Replacement Vapor Pad
6	GP4400-22	Pivot Pin
7	GF4400-09	Motor Mount
8	GF4400-08	Air Flow Adapter
9	GF4400-06	Crossflow Fan
10	GF4400-07	Fan Motor Cover
11	GF4400-13	Front Cover
12	GF1137-61	Relay Assembly
13	GF4400-11	Wire Harness
14	GF4400-12	Fan Motor Shield
15	GF4200-14	Drain Pan
Not Shown	GF4200-10	Spout
Not Shown	GFX4	Digital Humidistat with Furnace Blower Controller
Not Shown	DPDS00325	Quick Connect Tee valve w/Shut Off <small>(Replaces GP81-51SPV Saddle Valve Assembly Self Tapping)</small>
Not Shown	GP4200-38	<b>NEW</b> PEX Tubing Kit <small>(For GF3200DMM, GF4200DMM &amp; GF4400A) *Optional for All Other Humidifier Models*</small>

Prices shown are based on carton quantities. 5% surcharge for broken cartons. Effective July 1st, 2023, our minimum Order Value before H.S.T. is \$250. Replacement parts not included. A surcharge of \$25 on all orders under this minimum will be applied. All prices are subject to change without notice.

# Confidential Distributors List Prices

## GF3200DMM/DMD EVAPORATIVE HUMIDIFIER

- 3200 Square Foot Coverage, 12 GPD
- New Distributor Trough Design Distributes Water Evenly Over Pad
- Models include 1/2" OD, PEX water supply tubing (hi-temp and hi pressure) for hot or cold water installs. Eliminating the need for use of copper piping
- Low-Profile Cover Forces Air Through Vapor Pad at it's Warmest Point
- Snap-in-Place, Easy-Lift-Off Cover

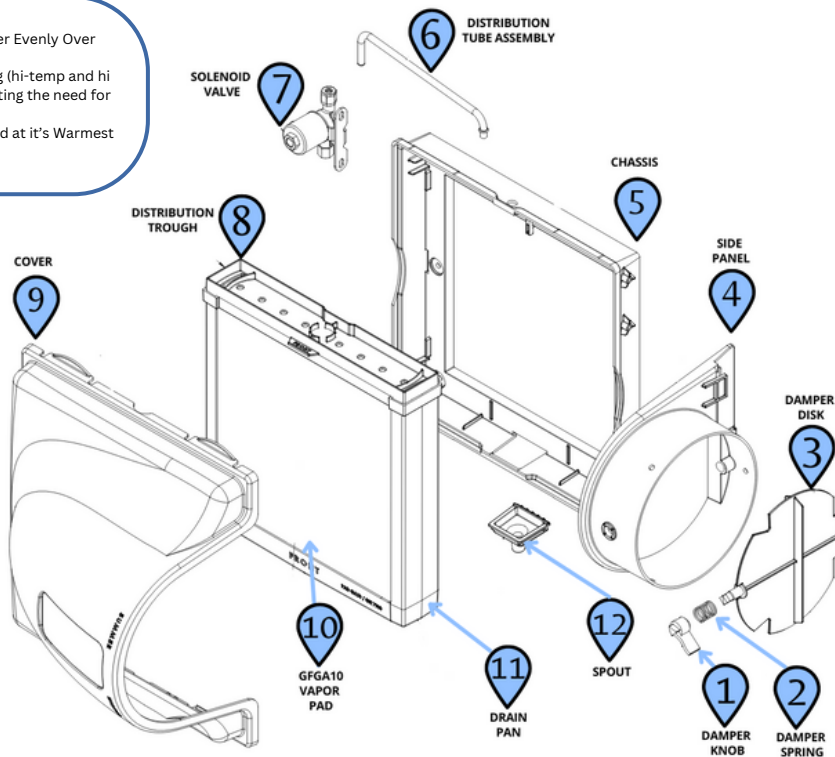

Diagram Number	Product Code	Description
N/A	GF3200DMM	Deluxe Flow Thru Humidifier w/ MHX3 Manual Humidistat
N/A	GF3200DMD	Deluxe Flow Thru Humidifier w/ GFX4 Digital Humidistat
1	GF900-11	Damper Knob
2	GF900-29	Damper Spring
3	GF900-28	Damper Disk
4	GF4200-02	Side Panel
5	GF3200-01	Chassis
6	GF4200-21	Distribution Tube Assembly
7	GF4200-05	Solenoid Valve
8	GF4200-15	<b>NEW</b> Distribution Trough
9	GF3200-13	Cover
10	GFGA10	Replacement Vapor Pad
11	GF3200-14	Drain Pan
12	GF4200-10	Spout
Not Shown	GFX4	Digital Humidistat with Furnace Blower Controller
Not Shown	GFMHX3	Manual Humidistat Wall or Duct Mount
Not Shown	GFP101	Compression Nut
Not Shown	GFP102	Compression Sleeve
Not Shown	GP4200-38	<b>NEW</b> PEX Tubing Kit (For GF3200DMM, GF4200DMM & GF4400A) *Optional for All Other Humidifier Models*

Prices shown are based on carton quantities. 5% surcharge for broken cartons. Effective July 1st, 2023, our minimum Order Value before H.S.T. is \$250. Replacement parts not included. A surcharge of \$25 on all orders under this minimum will be applied. All prices are subject to change without notice.

# Confidential Distributors List Prices

## GF4200DMM/DMD EVAPORATIVE HUMIDIFIER

- 4200 Square Foot Coverage, 17 GPD
- New Distributor Trough Design Distributes Water Evenly Over Pad
- Models include 1/2" OD, PEX water supply tubing (hi-temp and hi pressure) for hot or cold water installs. Eliminating the need for use of copper piping
- Low-Profile Cover Forces Air Through Vapor Pad at it's Warmest Point
- Snap-in-Place, Easy-Lift-Off Cover

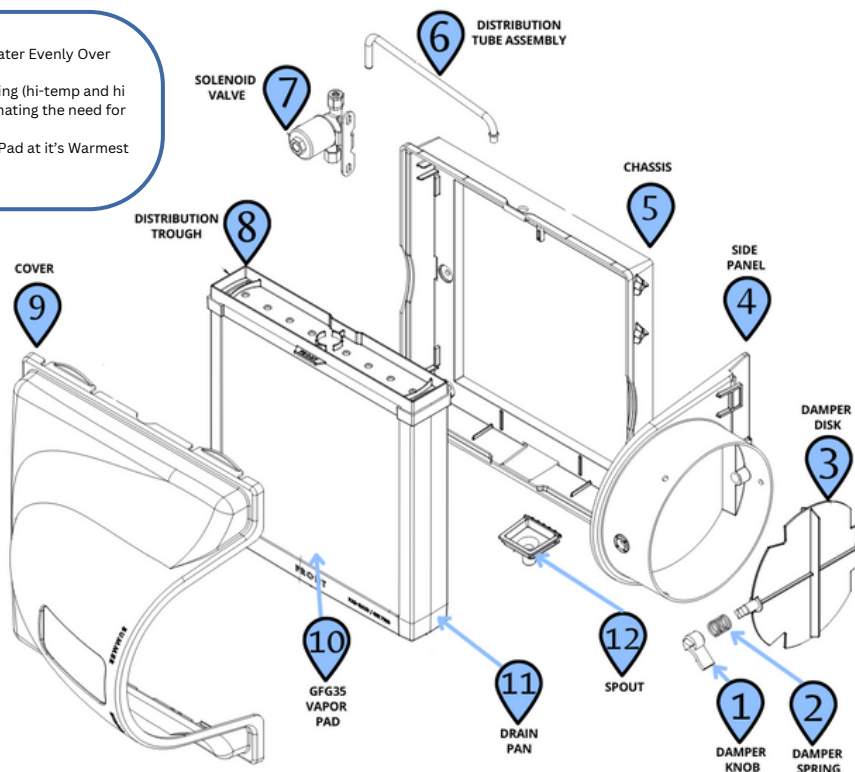

Diagram Number	Product Code	Description
N/A	GF4200DMM	Deluxe Flow Thru Humidifier w/ MHX3 Manual Humidistat
N/A	GF4200DMD	Deluxe Flow Thru Humidifier w/ GFX4 Digital Humidistat
1	GF900-11	Damper Knob
2	GF900-29	Damper Spring
3	GF900-28	Damper Disk
4	GF4200-02	Side Panel
5	GF4200-01	Chassis
6	GF4200-21	Distribution Tube Assembly
7	GF4200-05	Solenoid Valve
8	GF4200-15	<b>NEW</b> Distribution Trough
9	GF4200-13	Cover
10	GFGA35	Replacement Vapor Pad
11	GF3200-14	Drain Pan
12	GF4200-10	Spout
Not Shown	GFX4	Digital Humidistat with Furnace Blower Controller
Not Shown	GFMHX3	Manual Humidistat Wall or Duct Mount
Not Shown	GFP101	Compression Nut
Not Shown	GFP102	Compression Sleeve
Not Shown	GP4200-38	<b>NEW</b> PEX Tubing Kit (For GF3200DMM, GF4200DMM & GF4400A) *Optional for All Other Humidifier Models*

Prices shown are based on carton quantities. 5% surcharge for broken cartons. Effective July 1st, 2023, our minimum Order Value before H.S.T. is \$250. Replacement parts not included. A surcharge of \$25 on all orders under this minimum will be applied. All prices are subject to change without notice.



# Confidential Distributors List Prices

## GF1042DMM/DMD EVAPORATIVE HUMIDIFIER

- 2800 Square Foot Coverage, 17 GPD
- 2' Flexible Bypass Duct
- Quick Tee Connect Valve w/ Shut Off replacing Old Saddle Valve
- Optional Narrow Duct Adapter Plate
- 10' Water Supply Tubing, 10' Low Voltage Wire

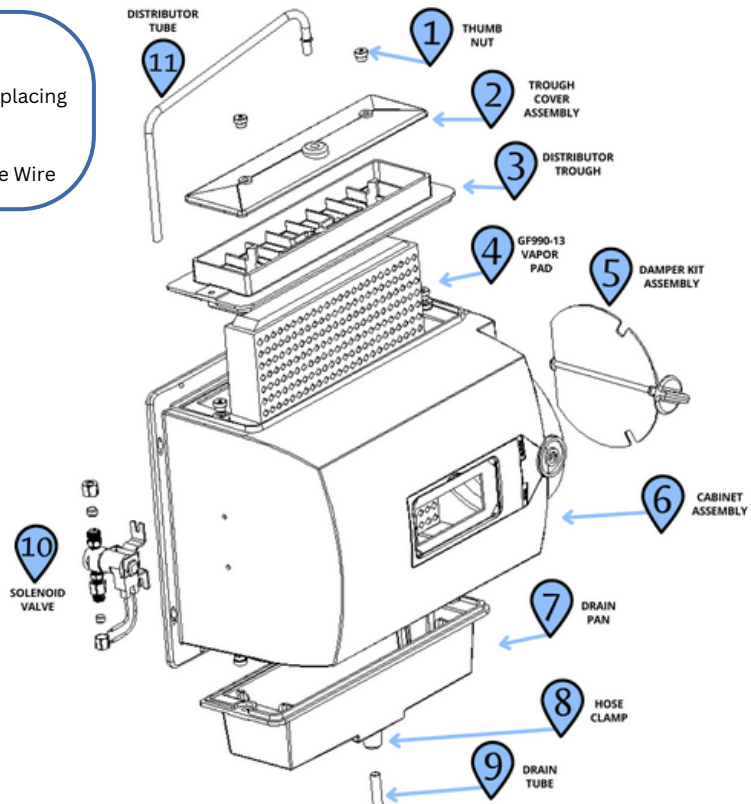

### DIAGRAM LIST

### PARTS NOT SHOWN

Diagram Number	Product Code	Description
N/A	GF1042DMM	Model 1042DMM w/ MHX3 Humidistat
N/A	GF1042DMD	Model 1042DMD w/ GFX4 Humidistat
1	GP1099-9	Thumb Nut
2	GF1137-35	Trough Cover Assembly
3	GF1137-4	Distributor Trough
4	GF990-13	Replacement Vapor Pad
5	GF1042-3	Damper Kit Assembly (Damper/Spring/Knob/Hardware)
6	GF104216	Cabinet Assembly 24V
7	GF1137-3	Drain Pan
8	GPP163	Hose Clamp for Drain Tube
9	GP1099-16	Drain Tube (15' of 5/8" ID)
10	GF990-53	Solenoid Valve 24V (Includes Fittings)
11	GF10425	Distributor Tube
Not Shown	GFX4	Digital Humidistat with Furnace Blower Controller
Not Shown	GFMHX3	Manual Humidistat. Wall or Duct Mount

Product Code	Description
GPP103	Compression Nut
GPP104	Compression Sleeve
GPP111	Connector Only
GF9903776	Orifice & Strainer Assembly (Standard Water Pressure: 40PSI-120PSI)
GF9903775	Orifice & Strainer Assembly (Standard Water Pressure: 20PSI-40PSI)
GP81-45	Transformer 24V
DPDS00325	1/2" Quick Connect Tee Valve w/Shut Off (Replaces GP81-51SPV Saddle Valve Assembly Self Tapping)
GP81-60	10' Poly Water Supply Kit
GP81-57	6" Flexible Bypass w/ Collar
GP1040AD	Humidifier Mounting/Adapter Plate
GP1040-13	Metal Plenum Ring
GF1042-20	Install Kit (Bypass Rings & Water Tubing Kit)
GF1042-80	Parts Bag (Solenoid, Thumb Nuts & Metal Screws)

Prices shown are based on carton quantities. 5% surcharge for broken cartons. Effective July 1st, 2023, our minimum Order Value before H.S.T. is \$250. Replacement parts not included. A surcharge of \$25 on all orders under this minimum will be applied. All prices are subject to change without notice.

**Confidential Distributors List Prices**  
**GF5500 STEAM HUMIDIFIER**

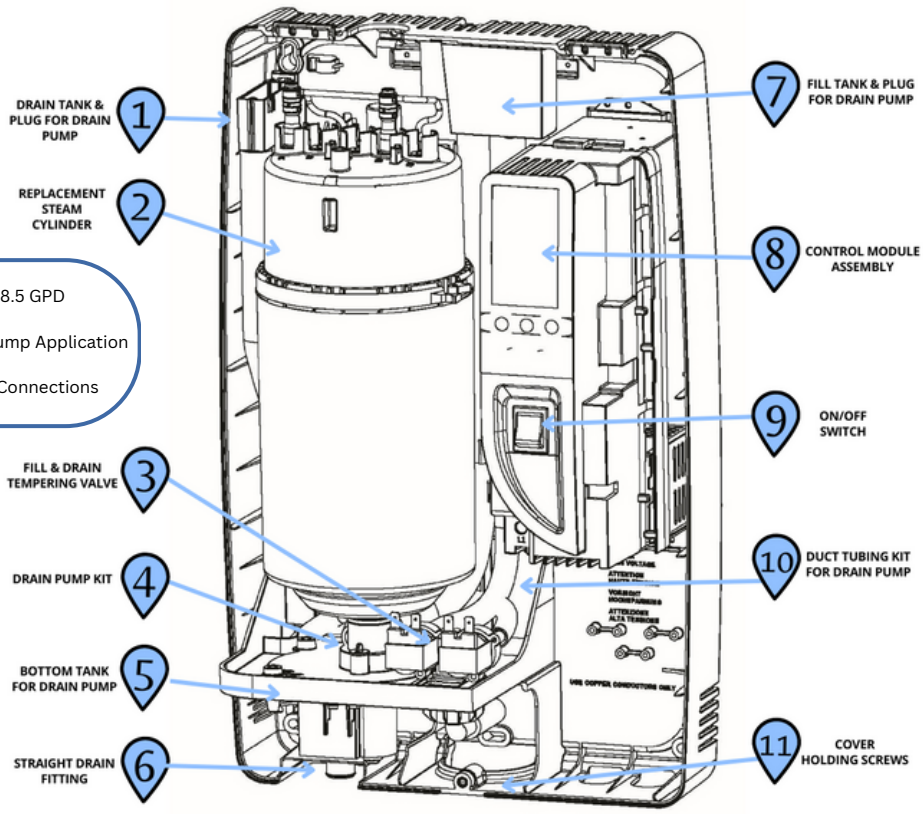

- 5500 Square Foot Coverage, 28.5 GPD
- Automatic Digital Control
- Suitable for Low-temp Heat Pump Application
- 1 Screw Cover Release
- "Snap in Place" Cylinder Wire Connections

Diagram Number	Product Code	Description
1	GF25-8	Drain Tank & Plug for Drain Pump
2	GF55	Replacement Steam Cylinder
3	GF5500-08	Fill & Drain Tempering Valve/Solenoid 230V
4	GF25-7	Drain Pump Kit
5	GF25-6	Bottom Tank for Drain Pump
6	GF5500-06	Straight Drain Fitting
7	GF25-2	Fill Tank & Plug for Drain Pump
8	GF5500-03	Control Module Assembly 115V/230V
9	GF35-18	On/Off Switch
10	GF25-5	Duct Tubing Kit for Drain Pump
11	GF35-25	Cover Holding Screws (For CH Series)
Not Shown	GFCHK7513002	7/8" ID Steam House (Min: 6') (Formerly GF-20:2)
Not Shown	GF5500-04	Internal Wire Kit
Not Shown	GF5500-05	3/4" ID Drain Hose (Pre-Cut of 10')
Not Shown	GF5500-01	Mounting Straps
Not Shown	GF5500-07	8" Steam Manifold
Not Shown	DPDS00325	1/2" Quick Connect Tee valve w/Shut Off
Not Shown	GFX4	Digital Humidistat with Furnace Blower Controller
Not Shown	GFRMB15R	Remote Blower for 110V (For GF5500 & DS15PBU)
Not Shown	GFRMB35R	Remote Blower for 230V (For GF5500, DS25PBU & DS25LCBU)

Prices shown are based on carton quantities. 5% surcharge for broken cartons. Effective July 1st, 2023, our minimum Order Value before H.S.T. is \$250. Replacement parts not included. A surcharge of \$25 on all orders under this minimum will be applied. All prices are subject to change without notice.

**Confidential Distributors List Prices**  
**DSRDAH ROTARY DISC HUMIDIFIER**

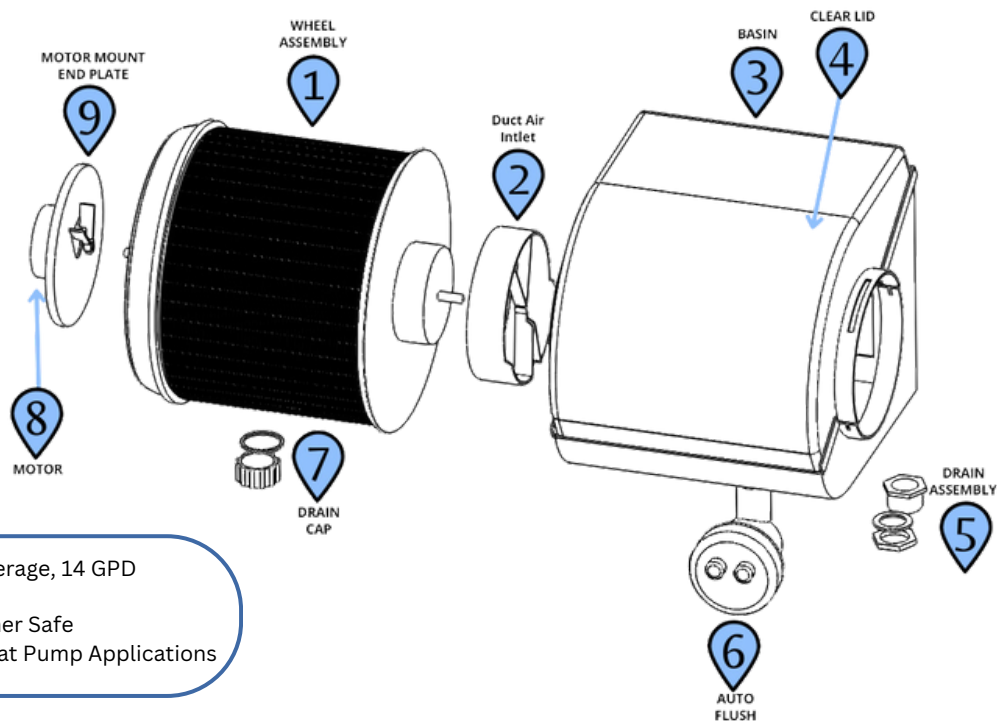

- 3200 Square Foot Coverage, 14 GPD
- No Vapor Pad Needed
- Disc Wheel is Dishwasher Safe
- Ideal Humidifier for Heat Pump Applications

Diagram Number	Product Code	Description
N/A	DSRDAH	Rotary Disc Humidifier
1	DPDS-WA	Wheel Assembly
2	DPDS00025-000	Duct Air Inlet
3	DPDS00004-000	Basin
4	DPDS00027-000	Clear Lid
5	DPDS00013-000	Drain Assembly
6	DPYL21039	Auto Flush (Stand Alone)
7	DPDS00009-000	Drain Cap with Washer
8	DPDS00091-005	Motor
9	DPDS00030-000	Motor Mount End Plate
Not Shown	DPDS00115	Motor Kit
Not Shown	DPDS-AF15	Auto Flush Kit
Not Shown	DPHHD030	Saddle Valve Assembly
Not Shown	DPDS00019-000	Float Valve
Not Shown	DPDS00046-000	24V/110V Plug-In Transformer
Not Shown	DPHEC020	24V/110V Hardwire Transformer
Not Shown	DPDS-BP	Bypass Kit
Not Shown	DPDS-WK	Water Connection Kit
Not Shown	DPDS00080	Current Sensor Relay
Not Shown	DPDS-OF	Overflow Kit
Not Shown	DPDS00206	Duct Collar with Damper
Not Shown	DPDS00021-000	Hanger Plate
Not Shown	DPDS-AX	Axle Assembly with Speed Clip

Prices shown are based on carton quantities. 5% surcharge for broken cartons. Effective July 1st, 2023, our minimum Order Value before H.S.T. is \$250. Replacement parts not included. A surcharge of \$25 on all orders under this minimum will be applied. All prices are subject to change without notice.

## Confidential Distributors List Prices

# GF3200PFT PULSE FLOW THROUGH HUMIDIFIER

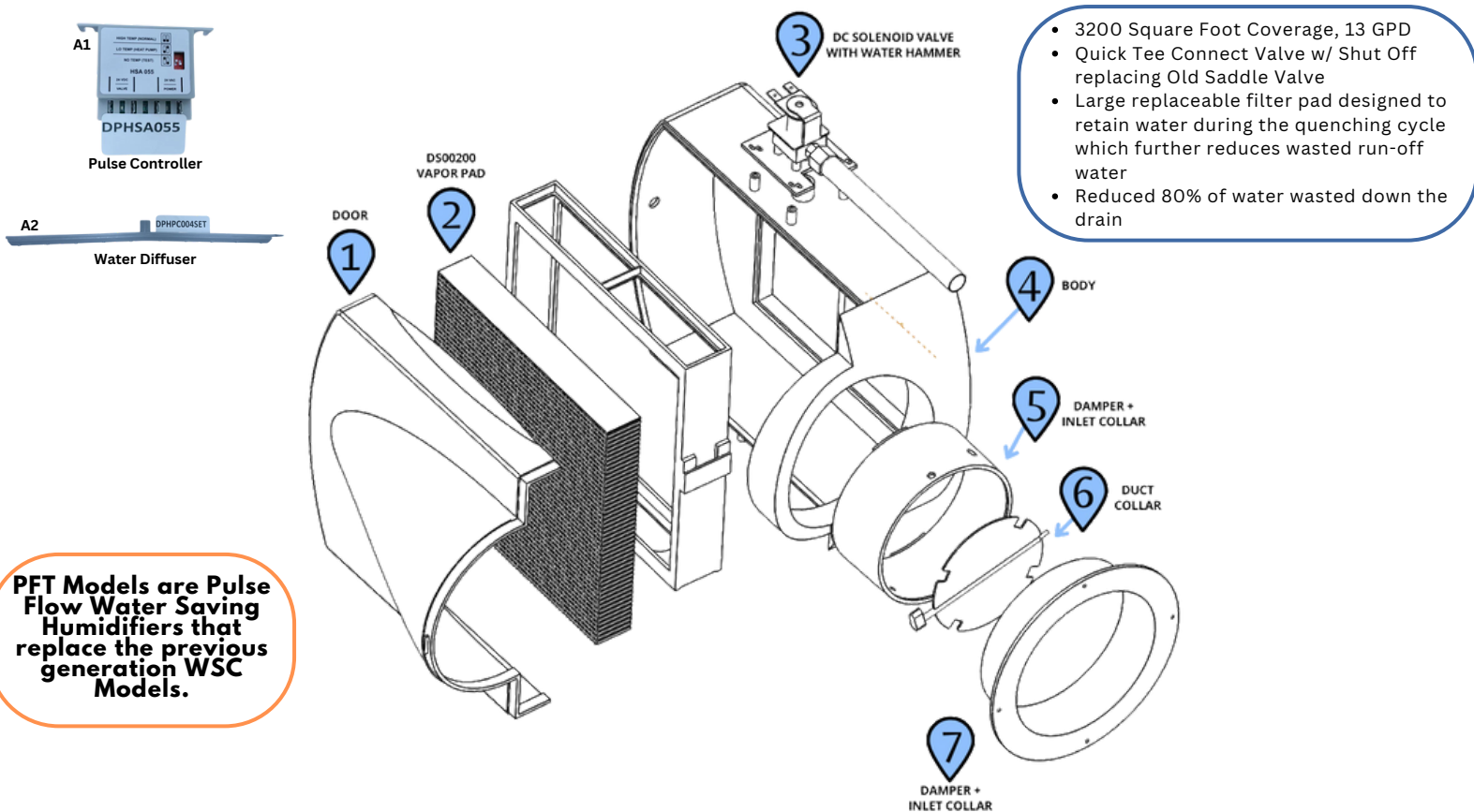

Diagram Number	Product Code	Description
N/A	GF3200PFT	Pulse Flow Thru with Patented Controller Humidifier
1	DPHPC008	Door
2	DPDS00200	Replacement Vapor Pad
3	DPHSA220	DC Solenoid Valve with Water Hammer
4	DPHPC006SET	Body
5	DPHPC002-012	Damper + Inlet Collar (Same as #7)
6	DPHPC020	Duct Collar
7	DPHPC002-012	Damper + Inlet Collar (Same as #5)
A1	DPHSA055	Pulse Flow Controller with Dip Switch
A2	DPHPC004SET	Water Diffuser
Not Shown	DPHEC020	Hardwire Transformer 115V/24V
Not Shown	DPDS00325	1/2" Quick Connect Tee Valve w/Shut Off
Not Shown	GFMHX3	Manual Humidistat Wall or Duct Mount
Not Shown	GP81-60	Water Supply Tubing Kit

Prices shown are based on carton quantities. 5% surcharge for broken cartons. Effective July 1st, 2023, our minimum Order Value before H.S.T. is \$250. Replacement parts not included. A surcharge of \$25 on all orders under this minimum will be applied. All prices are subject to change without notice.

## Confidential Distributors List Prices

# GF4200PFT PULSE FLOW THROUGH HUMIDIFIER

- 4200 Square Foot Coverage, 18 GPD
- Quick Tee Connect Valve w/ Shut Off replacing Old Saddle Valve
- Large replaceable filter pad designed to retain water during the quenching cycle which further reduces wasted run-off water
- Universal mounting
- Reduced 80% of water wasted down the drain

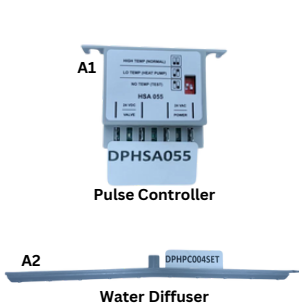

**PFT Models are Pulse Flow Water Saving Humidifiers that replace the previous generation WSC Models.**

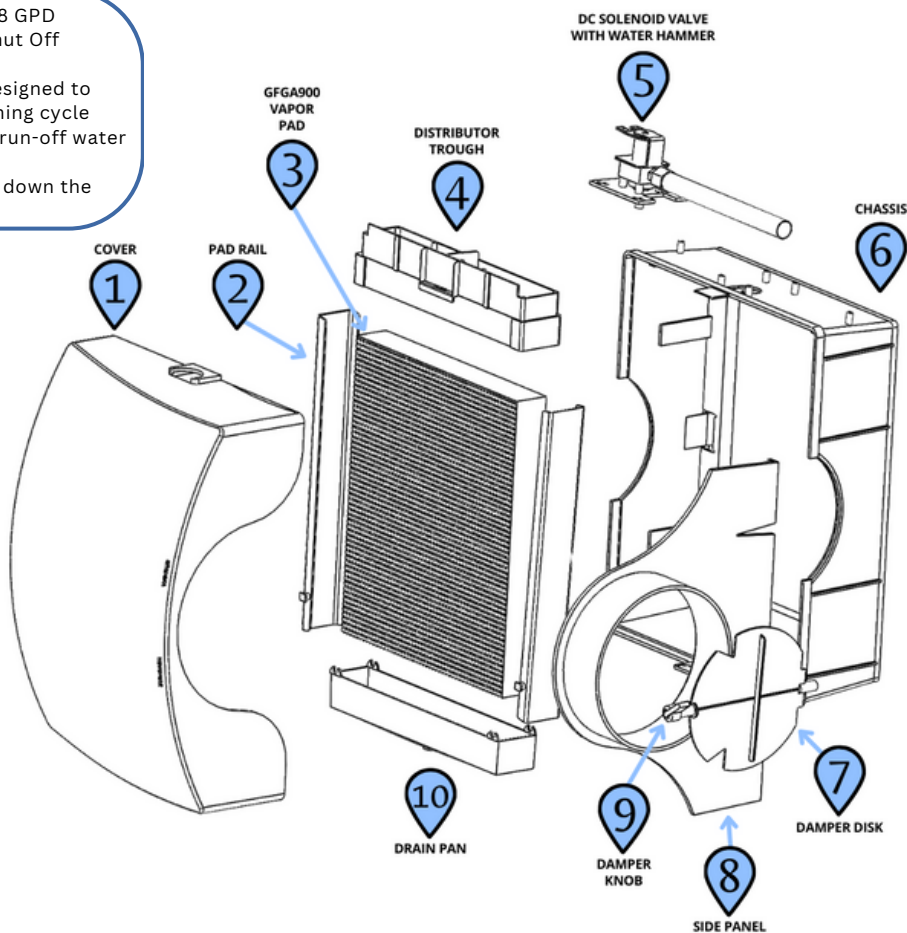
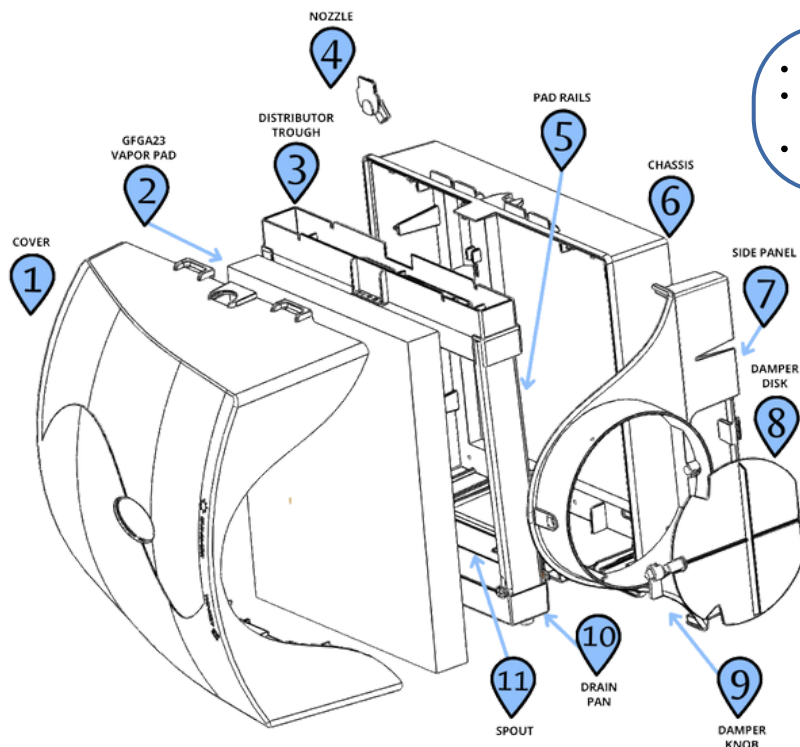

Diagram Number	Product Code	Description
N/A	GF4200PFT	Pulse Flow Thru with Patented Controller Humidifier
1	GF900-13	Cover
2	GF900-40	Pad Rail
3	GFGA900	Replacement Vapor Pad
4	GP900-15WSC	Distributor Trough
5	DPHSA220	DC Solenoid Valve with Water Hammer
6	GF900-1	Chassis
7	GF900-28	Damper Disk
8	GF900-2	Side Panel
9	GF900-11	Damper Knob
10	GF900-14	Drain Pan
A1	DPHSA055	Pulse Flow Controller with Dip Switch
A2	DPHPC004SET	Water Diffuser
Not Shown	DPHECO20	Hardwire Transformer 115V/24V
Not Shown	DPDS00325	1/2" Quick Connect Tee Valve w/Shut Off
Not Shown	GFMHX3	Manual Humidistat Wall or Duct Mount
Not Shown	GP81-60	Water Supply Tubing Kit

Prices shown are based on carton quantities. 5% surcharge for broken cartons. Effective July 1st, 2023, our minimum Order Value before H.S.T. is \$250. Replacement parts not included. A surcharge of \$25 on all orders under this minimum will be applied. All prices are subject to change without notice.



**Confidential Distributors List Prices**  
**GF1099LHS EVAPORATIVE HUMIDIFIER**



- 3000 Square Foot Coverage, 19 GPD
- Quick Tee Connect Valve w/ Shut Off replacing Old Saddle Valve
- Manual Humidistat

**DIAGRAM LIST**

**PARTS NOT SHOWN**

Diagram Number	Product Code	Description
N/A	GF1099LHS	Flow Through Bypass Humidifier w/MHX3 Manual Humidistat
1	GF950-13	Cover
2	GFGA23	Replacement Vapor Pad
3	GF950-15	Distributor Trough
4	GF900-9	Nozzle
5	GF900-40	Pad Rails
6	GF950-1	Chassis
7	GF950-2	Side Panel
8	GF950-5	Damper Disk
9	GF900-11	Damper Knob
10	GF950-14	Drain Pan
11	GF900-10	Spout
Not Shown	GFMHX3	Manual Humidistat

Product Code	Description
GFGA4235	Distributor Tube
GFGA4040	Solenoid Valve
GFGA4004	Strainer Screen
GFP102	Compression Sleeve (Copper)
GFP101	Compression Nut
GP81-29	Brass Insert Tube
GFGA4299	Orifice (Orange)
GP81-30	Compression Sleeve (Plastic)
GP81-60	Tubing Kit
GP81-45	Transformer
DPDS00325	Quick Connect Tee valve w/Shut Off <small>(Replaces GP81-51SPV Saddle Valve Assembly Self Tapping)</small>
GF1099-20	Old Replacement Vapor Pad <small>(For Models Made Before August 2008)</small>
GF109942	Old Solenoid Valve <small>(For Models Made Before August 2008)</small>
GF900-29	Damper Spring
GF9903776	Orifice/Strainer Assembly Standard
GF9903775	Orifice/Assembly Low

Prices shown are based on carton quantities. 5% surcharge for broken cartons. Effective July 1st, 2023, our minimum Order Value before H.S.T. is \$250. Replacement parts not included. A surcharge of \$25 on all orders under this minimum will be applied. All prices are subject to change without notice.



# Confidential Distributors List Prices

## GF1137L FAN POWERED HUMIDIFIER

- 3000 Square Foot Coverage, 18 GPD
- Easily Mounts on Warm Air Plenum
- Quiet Operation
- Cover is Made with UV Stable Automotive Grade Plastic for Long Lasting Durability

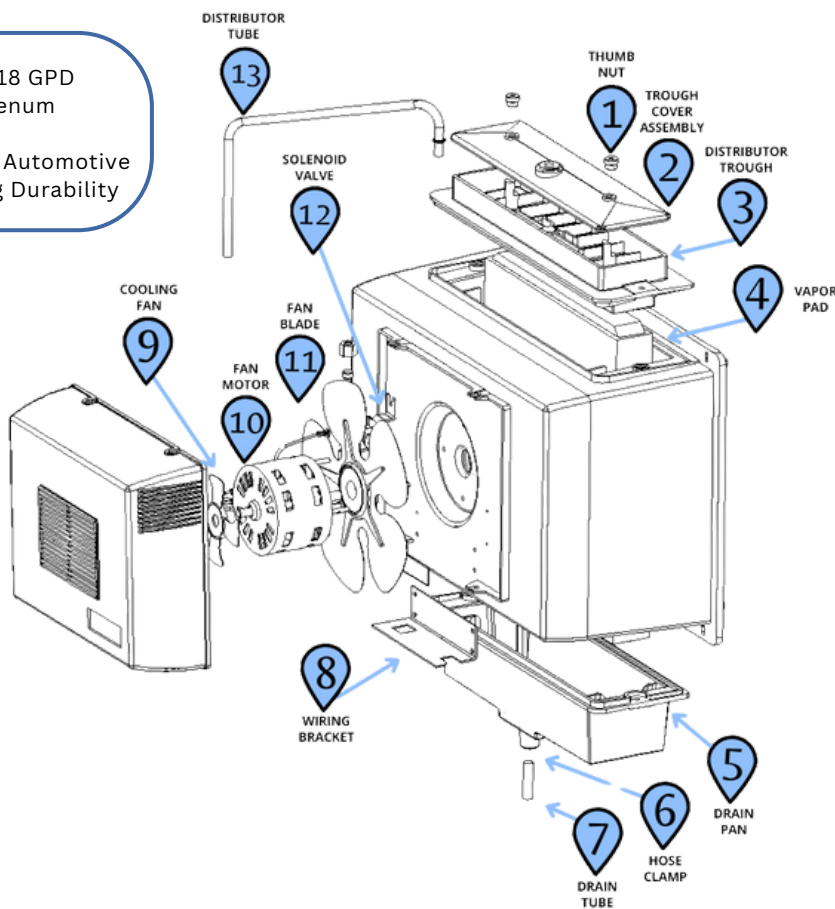

### DIAGRAM LIST

### PARTS NOT SHOWN

Diagram Number	Product Code	Description
N/A	GF1137L	Fan Powered Flow Through Humidifier
1	GP1099-9	Thumb Nut
2	GF1137-35	Trough Cover Assembly
3	GF1137-4	Distributor Trough
4	GF990-13	Replacement Vapor Pad
5	GF1137-3	Drain Pan
6	GPP163	Hose Clamp
7	GP1099-16	Drain Tube (15' 5/8" 1D)
8	GF1137-7	Wiring Bracket
9	GF1137-50	Cooling Fan
10	GF1137-8	Fan Motor
11	GF1137-9	Fan Blade
12	GF990-53	Solenoid Valve
13	GF1137-24	Distributor Tube
Not Shown	GFMHX3	Manual Humidistat Wall or Duct Mount

Product Code	Description
GFGA4238	Relay Assembly
GF1137-49	Fan Motor Grommet
GPP103	Compression Nut
GPP104	Compression Sleeve
GPP111	Connector Only
GF1137-20	Fan Guard
GF1137-2	Fan Shroud
GF1137-38	Cabinet Assembly
GF9903776	Orifice & Strainer Assembly (Standard Water Pressure: 40PSI-120PSI)
GF9903775	Orifice & Strainer Assembly (Standard Water Pressure: 20PSI-40PSI)
GF1137-15	Mounting Stud
GF1137-31	Power Supply Cord
GF1137-39	Front Cover Assembly
GF1137-17	Old Solenoid Valve (Use For Models Purchased before July 2006)

Prices shown are based on carton quantities. 5% surcharge for broken cartons. Effective July 1st, 2023, our minimum Order Value before H.S.T. is \$250. Replacement parts not included. A surcharge of \$25 on all orders under this minimum will be applied. All prices are subject to change without notice.



## Confidential Distributors List Prices

# LEGACY ELITE STEAM PARTS

### STEAM CYLINDERS

Product Code	Description
GF15-14	Replacement Steam Cylinder for DS15
GF35-14	Replacement Steam Cylinder for DS35/RS35
GF35-15	Replacement Low Conductivity Cylinder for DS35/RS35
GF20-14	Replacement Steam Cylinder for DS20 & RS20
GF50-14	Replacement Steam Cylinder for DS50
GF50-15	Replacement Low Conductivity Cylinder for DS50

### OTHER PARTS

Product Code	Description
GF20-4	Water Line Connector (For DS15P, DS25P, DS25LC, RS15P & RS25P)
GF7531-15-50	90° Drain Adapter w/ Barbed Fitting (For DS15P, DS25P, DS25LC, RS15P & RS25P)
GF20-1	Steam Nozzle (For DS15P, DS25P & DS25LC)
GFDPO30D22RU	12" 22mm 7/8" Steam Manifold with 9' Condensate Hose
GFDPO450D22RO	17 1/2" 22mm 7/8" Steam Manifold with 9' Condensate Hose
GFCHK7513002	7/8 ID Steam Hose (6') Priced Per Ft. (For DS15P, DS25P, DS25LC & GF5500) (Formerly GF-20:2)
GF25-23	9' Condensate Hose 1/4"ID (Pre Cut 9ft) (For DS15P, DS25P, DS25LC, RS15P & RS25P)
GF7611	Blower Filter Kit (For DS15P, DS25P, DS25LC, RS15P & RS25P)
GP81-60	10' Water Supply Tubing Kit
GF25-50	Wiring Harness including Drain Pump Wiring Kit (For DS15P/DS25)
GF12500	Air Pressure Sensing Switch
GFAP2	AP2 Accessory Conductivity Meter
GFX4	Digital Humidistat with Furnace Blower Controller
GF25-8	Drain Pump Tank Reservoir & Cover
GF50-27	3/8" Condensate Hose in DPO Kits (Per Ft.)
GFHC201	High Limit Humidistat
GF1312502AXX	Red O-Ring (For DS15P, DS25P & DS25LC)
GF25-12	Steam Cylinder Hose Adapter (For DS15P, DS25P & DS25LC)
GF15-5	Control Module/Board 120V (DS15P & RS15P)
GF15-6	Fill & Tempering Valve/Solenoid 120V (DS15P)
GF15-7	Drain Pump Assembly 120V (For DS15P)
GF25-1	Control Module/Board 230V (For DS25P/DS25LC)
GF25-3	Fill & Tempering Valve/Solenoid 230V (For DS25P/DS25LC)
GF25-7	Drain Pump Assembly 230V (For DS25P/DS25LC)
DPDS00325	1/2" Quick Connect Tee valve w/ Shut Off
GF35-21	90° Drain Elbow

Prices shown are based on carton quantities. 5% surcharge for broken cartons. Effective July 1st, 2023, our minimum Order Value before H.S.T. is \$250. Replacement parts not included. A surcharge of \$25 on all orders under this minimum will be applied. All prices are subject to change without notice.



**Confidential Distributors List Prices**  
**DEHUMIDIFIERS**



- Touch Screen
- Wi-Fi Capabilities
- Filter Change Reminder
- Optional Hanging Kit
- Compact Design



**DH75**  
75 Pints Per 24 Hours  
120V & 180CFM  
4000 Sq. Ft.

**DH100**  
100 Pints Per 24 Hours  
120V & 220CFM  
6000 Sq. Ft.

Product Code	Description
GFDH75	Dehumidifier with Capacity of 75 Pints Per Day
GFDH100	Dehumidifier with Capacity of 100 Pints Per Day
GF7145	DH75 Collar Kit
GF7146	DH100 Collar Kit
GF6560	Hanging Kits for DH Units
GF7375	<b>NEW</b> 6.0 Display Control Board Kit (For DH75 & DH100)
GF7143	MERV 11 Filter for DH75
GF7144	MERV 11 Filter for DH100
GF7133	MERV 11 Filter for DH70
GF7134	MERV 11 Filter for DH95
GF6500	Drain Pan for DH70
GFDC1	Dehumidistat Control (For DH70 & DH95)

Prices shown are based on carton quantities. 5% surcharge for broken cartons. Effective July 1st, 2023, our minimum Order Value before H.S.T. is \$250. Replacement parts not included. A surcharge of \$25 on all orders under this minimum will be applied. All prices are subject to change without notice.

**Confidential Distributors List Prices**  
**AIR CLEANERS**

**MAC AIR CLEANERS & REPLACEMENT FILTER MEDIA**

Product Code	Description
GFMAC2000-11	20 x 25 Mega MAC Air Cleaner
GFMAC1400-11	16 x 25 Mighty MAC Air Cleaner
GFMAC1200	16 x 25 Mini MAC Air Cleaner
GFMAC2020-11	20 x 20 Mighty MAC Air Cleaner
GFMAACL	Right Angle MAC Air Cleaner
GF4551	20 x 25 x 5 <b>MERV 11</b> Replacement Filter for MAC2000-11 & MAACL GF2025-11 & Perfect Platform
GF4541	16 x 25 x 5 <b>MERV 11</b> Replacement Filter for MAC1400-11 & GF1625-11
GF4521	16 x 25 x 3 <b>MERV 8</b> Replacement Filter for MAC1200
GF4556	20 x 20 x 5 <b>MERV 11</b> Replacement Filter for MAC2020-11
GF4547	16 x 25 x 5 <b>MERV 13</b> Replacement Filter for MAC1400-11 & GF1625-11
GF4557	20 x 25 x 5 <b>MERV 13</b> Replacement Filter for MAC2000-11, MAACL, GF2025-11 & Perfect Platform



**GFMAACL**  
Right Angle Air Cleaner



**GFMAC2020-11**  
MAC Air Cleaner

**GENERALAIRE AIR CLEANERS & REPLACEMENT FILTER MEDIA**

Product Code	Description
GF1625-11	16 x 25 x5 High Efficiency Air Cleaner
GF2025-11	20 x 25 x 5 High Efficiency Air Cleaner
GF4551	20 x 25 x 5 <b>MERV 11</b> Replacement Filter for MAC2000-11 & MAACL GF2025-11 & Perfect Platform
GF4541	16 x 25 x 5 <b>MERV 11</b> Replacement Filter for MAC1400-11 & GF1625-11
GF4547	16 x 25 x 5 <b>MERV 13</b> Replacement Filter for MAC1400-11 & GF1625-11
GF4557	20 x 25 x 5 <b>MERV 13</b> Replacement Filter for MAC2000-11, MAACL, GF2025-11 & Perfect Platform



**GF4551 MERV 11 Filter**  
**GF4557 MERV 13 Filter**

**PERFECT PLATFORMS**

Product Code	Description
GFGAFB2832-11	28.5 x 32 Perfect Platform (Good to 2 1/2 Ton Application)
GFGAFB2843-11	28.5 x 43 Perfect Platform (Good to 3-5 Ton Application)
GF4551	20 x 25 x 5 <b>MERV 11</b> Replacement Filter for Perfect Platform
GF4557	20 x 25 x 5 <b>MERV 13</b> Replacement Filter for Perfect Platform

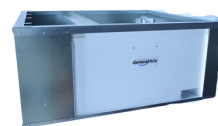

**GFGAFB2832-11**  
Perfect Platform

- For Gas & Electric Furnaces and Air Handlers
- Heavy 22 Gauge Galvanize Sheet Metal
- Fits MERV 11 & MERV 12 Filters

Prices shown are based on carton quantities. 5% surcharge for broken cartons. Effective July 1st, 2023, our minimum Order Value before H.S.T. is \$250. Replacement parts not included. A surcharge of \$25 on all orders under this minimum will be applied. All prices are subject to change without notice.

**Confidential Distributors List Prices**

**200/400D Versions**  
Residential Applications  
Ducted into Return Ducting  
before Air Cleaner

**AIR CLEANERS**

**200/400R Versions**  
Institutional Applications  
(Classrooms, Small Offices,  
Board Rooms)

**HEPA AIR CLEANERS**



GF400D HEPA Air Cleaner

Product Code	Description
GF200D	Surface or Return Duct Mount HEPA Air Cleaner (200 CFM, Covers 2200 Sq. Ft.)
GF200R	Portable Room HEPA Air Cleaner (200 CFM, Covers 2200 Sq. Ft.)
GF400D	Surface or Return Duct Mount HEPA Air Cleaner (400 CFM, Covers 4200 Sq. Ft.)
GF400R	Portable Room HEPA Air Cleaner (400 CFM, Covers 4200 Sq. Ft.)
GF4645	HEPA Filter (200 & 400 Models) (Changed Bi-Annually)
GF4646	Pre Filter w/Charcoal (200 & 400 Models) (Changed 3-6 Months)

**TERSUS AIR CLEANERS**



GFT2000 Tersus Air System

Product Code	Description
GFT1200	17 x 25 x 10 Tersus 1200 Air System
GFT2000	21 x 25 x 10 Tersus 2000 Air System
GF4572	<b>MERV 13</b> Replacement Media for T1200
GF4562	<b>MERV 13</b> Replacement Media for T2000
GF4567	LED Service Panel
SFLT016	Replacement UV Lamp (2 Required)

**AC MODELS**



GFAC22 Air Cleaner

GFAC22	High Efficiency Air Cleaner
GFAC24	High Efficiency Air Cleaner
GFAC12758	20 x 25 x 6 <b>MERV 11</b> Expandable Media (For AC1 & AC22)
GFAC12880	20 X 25 X 6 <b>MERV 11</b> Expandable Strung Media (For AprilAire 2200 & 2250)
GF13156	16 x 27 x 6 <b>MERV 11</b> Expandable Media (For AC24 & April Aire 2400)
GF13415	16 x 27 x 6 <b>MERV 11</b> Expandable Media for AC4

**HONEYWELL REPLACEMENT FILTERS**

Product Code	Description
GF4366	16 x 25 X 4 <b>MERV 11</b> Replacement Filter for Honeywell
GF4367	20 x 20 X 4 <b>MERV 11</b> Replacement Filter for Honeywell
GF4368	20 x 25 X 4 <b>MERV 11</b> Replacement Filter for Honeywell

Prices shown are based on carton quantities. 5% surcharge for broken cartons. Effective July 1st, 2023, our minimum Order Value before H.S.T. is \$250. Replacement parts not included. A surcharge of \$25 on all orders under this minimum will be applied. All prices are subject to change without notice.



## Confidential Distributors List Prices



### **UVC AIR PURIFIERS** **RESIDENTIAL AIR PURIFIERS**

Product Code	Description
SF2414	24V UVC Coil Clean Air Purifier (14" Lamp)
SF2414PREMIUM	24V UVC Coil Clean & Return Duct Air Purifier (14" Lamp)
SF2018	Single Lamp UVC PCO Air Purifier
SF2000	Dual Lamp UVC PCO Air Purifier
SF2000-230	Dual Lamp UVC PCO Air Purifier with 230/240V Plug In Power Cord

### **RESIDENTIAL REPLACEMENT LAMPS**

Product Code	Description
SF1082LR	1 Year Replacement Lamp for SF2414
SF1082LR-TC	2 Year Replacement Lamp for SF2124C or SF2414
SF1082 SIPT	Optional SOS 2 Year Replacement Lamp for SF2124C or SF2414
SF102-959	2 Year Replacement Shatterproof Lamp for SF-2414 Premium
SF1076R	1 Year Replacement Lamp for SF-2018, SF-2000 & SF-2000-230
SF1076R-03	Optional SOS 2 Year Replacement Lamp for SF-2018, SF-2000 & SF-2000-230
SFLSK36	Replacement Lamp for GUV100A83
SFLT50	Replacement Lamp for PCO2450

### **RESIDENTIAL REPLACEMENT BALLASTS**

Product Code	Description
SF010303	Replacement Ballast for SF2414 Premium and SF2124C
SF010090	Replacement Ballast for SF2414
SF1060E-R	Replacement Ballast for SF2018, SF2000, SF2000-230, SF9000(16X25) & SF9000(20X25)

### **OTHER PARTS**

Product Code	Description
SF102-998	Indoor Air Quality Test Kit

Prices shown are based on carton quantities. 5% surcharge for broken cartons. Effective July 1st, 2023, our minimum Order Value before H.S.T. is \$250. Replacement parts not included. A surcharge of \$25 on all orders under this minimum will be applied. All prices are subject to change without notice.





**Confidential Distributors List Prices**



**UVC AIR PURIFIERS**

**COMMERCIAL AIR PURIFIERS**

Product Code	Description
SF2000-2300D	Hardwire UVC PCO Air Purifier (Twin 18" Lamps)
SF3018	Hardwire UVC Air Purifier (Single 18" Lamp)
SF3024	Hardwire UVC Air Purifier (Single 24" Lamp)
SF3032	Hardwire UVC Air Purifier (Single 32" Lamp)
SF5009SL	Hardwire UVC PCO Air Purifier (Single 9" Lamp)
SF5009DL	Hardwire UVC PCO Air Purifier (Twin 9" Lamps)
SF5018SL	Hardwire UVC PCO Air Purifier (Single 18" Lamp)
SF5018DL	Hardwire UVC PCO Air Purifier (Twin 18" Lamp)
SF5036SL	Hardwire UVC PCO Air Purifier (Single 32" Lamp)
SF5036DL	Hardwire UVC PCO Air Purifier (Twin 32" Lamp)

**COMMERCIAL REPLACEMENT LAMPS**

Product Code	Description
SF1076-1RSP	1 Year Replacement Lamp for SF2000-2300D & SF3018
SF1097BR-SP	1 Year Replacement Lamp for SF3024
SF1081-1RSP	1 Year Replacement Lamp for SF3032
SF1068B-R	1 Year Replacement Lamp for SF5009SL & SF5009DL
SF1076R	1 Year Replacement Lamp for SF5018SL & SF5018DL
SF1081-2R	1 Year Replacement Lamp for SF5036SL & SF5036DL

**COMMERCIAL REPLACEMENT BALLASTS**

Product Code	Description
SF5000B-R	Replacement Ballast for All Commercial UVC Air Purifiers

**OTHER PARTS**

Product Code	Description
SF5000T	74" Stainless Steel Mounting Track with End Bracket (To Suspend DL/SL UV Models across Ductwork)
SF5000C	Track Connectors (Joins Two 5000T's Together)

Prices shown are based on carton quantities. 5% surcharge for broken cartons. Effective July 1st, 2023, our minimum Order Value before H.S.T. is \$250. Replacement parts not included. A surcharge of \$25 on all orders under this minimum will be applied. All prices are subject to change without notice.



## Confidential Distributors List Prices



### FUEL OIL FILTERS

#### OIL FILTERS

Product Code	Description
GF1A25B	General Oil Filter with BioGasket (10GPH Firing Rate)
GF2A700B	General Oil Filter with BioGasket (25GPH Firing Rate)
GF2A17AW 1/2"	1/2" Multi-Purpose Filter
GF2A17AW 3/4"	3/4" Multi Purpose Filter
GFCGF10K	General Spin On Oil Filter

#### REPLACEMENT CARTRIDGES

Product Code	Description
GFK10GF	General Spin On Oil Filter (Cartridge Fits CGF10 or CM10GF)
GF1A30P	Wool Felt Blue Bonded Replacement Cartridge (Fits GF1A25B)
GF2A710P	Wool Felt Replacement Cartridge (Fits GF2A700B)
GFRF1	Rayon Fiber Replacement Cartridge (Fits GF1A25B)
GFRF2	Rayon Fiber Replacement Cartridge (Fits GF2A700B)
GFG	Epoxy Coated Replacement Cartridge (Fits Spin On Filters)
GF2A710SL	Replacement Cartridge (Fits GF2A17AW) <small>*Please Specify 30, 60, 100 or 200 Monel Mesh*</small>

#### FILTER BOWL REPAIR KIT

Product Code	Description
GF10542	Filter Bowl Repair Kit for 1A25B/77
GF10821	Filter Bowl Repair Kit for 2A700/99

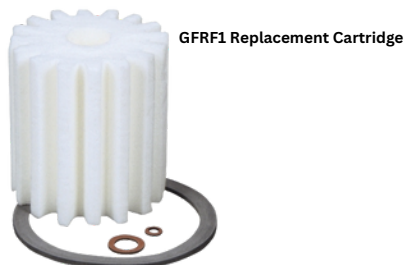

Prices shown are based on carton quantities. 5% surcharge for broken cartons. Effective July 1st, 2023, our minimum Order Value before H.S.T. is \$250. Replacement parts not included. A surcharge of \$25 on all orders under this minimum will be applied. All prices are subject to change without notice.



## Confidential Distributors List Prices



### OIL ACCESSORIES

Product Code	Description
GFCGFHEAD20	Head Only for CGF10K & GFCM10GF
GF100UL	44" ULC Approved Tank Gauge
GP100B	Top Plastic for GF100UL
GP100LN	Rubber Gasket for GF100UL
GF100GPU	Metal Cover Tank Gauge Protector
GF124	1/2" x 3/8" Tank Valve
GF130	Oil Tank Valve with 90° Ball Valve
GF125Z	1 1/4" Zinc Vent Cap
GF200Z	2" Zinc Fill Cap
GF201	2" Threaded Fill Cap
GF200VA	2" Aluminum Vent Cap
GF202	2" Locking Fill Cap
GF2126	2" x 1 1/4" x 1 1/4" Tank Whistle
GFCGFHEAD20	Head Only for CGF10K & GFCM10GF
GFB	Bracket for Spin On Filter Head
GFFRI	Fuel Restriction Indicator
GFGK3	Gasket for 2A17AW (BioGasket)
GF11V	1" Aluminum Spin On Head
GFTAP90BVULC	Tank Accessory Kit with 90° Ball Valve Bottom Outlet
GFTAPECO	Tank Accessory Kit with MTCO Valve End Outlet
GFTAPECO-4	Tank Accessory Kit with No Tank Valve
GF3000	EZ Change Filter Draining System
GFBG51A	BioGasket for 1A25B/77
GFBG52A	BioGasket for 2A700

Prices shown are based on carton quantities. 5% surcharge for broken cartons. Effective July 1st, 2023, our minimum Order Value before H.S.T. is \$250. Replacement parts not included. A surcharge of \$25 on all orders under this minimum will be applied. All prices are subject to change without notice.

**Confidential Distributors List Prices**



**OIL FILTERS**

**RESIDENTIAL OIL FILTERS**

Product Code	Description
GFR	Gar-Ber Replacement Spin On Cartridge
GF11V-R	Gar-Ber Spin On Fuel Oil Filter
GF11BV-R	Gar-Ber Spin On Fuel Oil Filter with Bracket
GF11BV-RK	Gar-Ber Oil Filter with Restriction Indicator Gauge and Bracket

**COMMERCIAL OIL FILTERS**

Product Code	Description
GFM	Gar-Ber Replacement Spin On Cartridge
GF11BV-M	Gar-Ber Spin On Fuel Oil Filter with Bracket
GF11BV-MK	Gar-Ber Oil Filter with Restriction Indicator Gauge and Bracket

**WATER BLOCK FILTERS**

Product Code	Description
GFR2000	Replcmt Spin On Water Block Cartridge

GFR Replacement Spin On Cartridge



GF11V-R Fuel Oil Filter



Prices shown are based on carton quantities. 5% surcharge for broken cartons. Effective July 1st, 2023, our minimum Order Value before H.S.T. is \$250. Replacement parts not included. A surcharge of \$25 on all orders under this minimum will be applied. All prices are subject to change without notice.



## Confidential Distributors List Prices



TJERNLUND PRODUCTS, INC.

### PRESSURE SWITCHES & APPLIANCE INTERLOCK PRODUCTS

Product Code	Description
TJPS-1503	Duct Air Stat Positive Pressure Air Switch
TJPS-2501	Pressure Stat Pos/Neg Pressure Air Switch
TJUC1	Universal Control
TJMAC1E	Appliance Interlock 115/24V (For Use with UC1)
TJMAC4E	4 Appliance Interlock 115/24V (For Use with UC1)

### UNDERAIRE CRAWL SPACE VENTILATORS

Product Code	Description
TJV1	Crawl Space Ventilator (110 CFM)
TJV1D	Crawl Space Vent with Dehumidistat (110 CFM)
TJV2D	Crawl Space Vent with Dehumidistat (220 CFM)
TJDH10	Dehumidistat
TJDH2P	Dehumidistat with Two 115 Outlets for CS1 & CS2

### NO CLOG DRYER DUCT BOOSTER

Product Code	Description
TJLB2	No Clog Dryer Duct Booster (Res 160 CFM)

### WATER HEATER VENT SYSTEM MILLIVOLT CONTROLS & SPILLAGE SWITCH KIT

Product Code	Description
TJWHKE	Millivolt Water Heater Interlock (For use with UC1)

### SIDE WALL RADON MITIGATION SYSTEM

Product Code	Description
TJRMS160	Radon Vac Includes Stainless Steel Vent Hood
TJRA1	Radon Fan Failure Alarm

Prices shown are based on carton quantities. 5% surcharge for broken cartons. Effective July 1st, 2023, our minimum Order Value before H.S.T. is \$250. Replacement parts not included. A surcharge of \$25 on all orders under this minimum will be applied. All prices are subject to change without notice.



## Confidential Distributors List Prices



TJERNLUND PRODUCTS, INC.

### ROOF TOP INDUCERS

Product Code	Description
TJRT750	Rooftop Inducer w/PSA-1 for Gas & Oil (Commercial)
TJRT750H	Rooftop Inducer with Speed Control for Solid Fuel Fireplaces and Ovens
TJRTS8	Rooftop Stand for RT750
TJDH750	Discharge Hood with Damper RT750 Series
TJRT1500	Rooftop Inducer w/PSA-1 for Gas & Oil (Commercial)
TJRT1500H	Rooftop Inducer with Speed Control for Solid Fuel Fireplaces and Ovens
TJRTS12	Rooftop Stand for RT1500
TJDH1500	Discharge Hood with Damper RT1500 Series
TJUCRT	Universal Control with Speed Control
TJCOP2	Constant Operating Pressure Control (Optional) <small>*Not Included with Models, Must be Ordered Separately*</small>

### BALANCING BAFFLES

Product Code	Description
TJABD4	4" Stainless Steel Balancing Baffle
TJABD6	6" Stainless Steel Balancing Baffle
TJABD8	8" Stainless Steel Balancing Baffle
TJABD10	10" Stainless Steel Balancing Baffle

### AIRSHARE VENTILATORS

Product Code	Description
TJAS1	Airshare Room to Room Ventilator-Hard Wired
TJASLL	Airshare Level to Level Transfer Fan
TJSWS	Airshare Wireless Wall Switch Control
TJSWT	Airshare Wireless Thermostat Control Heat Only

### XCHANGER BASEMENT FAN

Product Code	Description
TJX2D	XChanger Basement Fan
TJDT2-6	Dual 6" Duct Connectors
TJSCP	Plug-In Speed Control

Prices shown are based on carton quantities. 5% surcharge for broken cartons. Effective July 1st, 2023, our minimum Order Value before H.S.T. is \$250. Replacement parts not included. A surcharge of \$25 on all orders under this minimum will be applied. All prices are subject to change without notice.





**Confidential Distributors List Prices**



TJERNLUND PRODUCTS, INC.

**IN LINE DRAFT INDUCER PARTS**

**AD-1**

Product Code	Description
TJAD-1	Auto Draft Inducer for Wood & Coal Stoves
TJ950-8000	Housing Kit
TJ950-3012	Wheel Kit
TJ950-3022C	Motor Kit
TJ950-4030	Speed Control Kit

**DJ-3**

Product Code	Description
TJDJ-3	Inducer Std 115V/60HZ/1550RPM/35W Includes PS1505 CSA Approved
TJ950-3000	Housing Kit
TJ950-3010	Wheel Kit
TJ950-3020C	Motor Kit

**D-3**

Product Code	Description
TJD3	Inducer Std 115V/60HZ/1550RPM/74W Includes PS1505 CSA Approved
TJ950-3002	Housing Kit
TJ950-3012	Wheel Kit
TJ950-3022C	Motor Kit

**I**

Product Code	Description
TJI	Inducer Std 115V/60HZ/1725RPM/¼HP/5.4Amps
TJ950-4000	Housing Kit
TJ950-4010	Wheel Kit (Also for Discontinued I-R)
TJ950-4020	Can 1/3 HP Motor Kit (Also for Discontinued I-R)
TJ950-4025	Shaft Extension Kit

Prices shown are based on carton quantities. 5% surcharge for broken cartons. Effective July 1st, 2023, our minimum Order Value before H.S.T. is \$250. Replacement parts not included. A surcharge of \$25 on all orders under this minimum will be applied. All prices are subject to change without notice.

**Confidential Distributors List Prices**



TJERNLUND PRODUCTS, INC.

**IN LINE DRAFT INDUCER PARTS**

**IL**

Product Code	Description
TJIL	Inducer Std 115V/60HZ/1725RPM/¼HP/5.4Amps
TJ950-5000	Housing Kit
TJ950-5010	Wheel Kit (Also for Discontinued IL-R)
TJ950-4020	Can 1/4HP Motor Kit
TJ950-4025	Shaft Extension Kit

**HD**

Product Code	Description
TJHD	Inducer Std 230 or 460V/60HZ/1725RPM/2HP/6.4Amps Flat or Round
TJ950-0117	Belt Kit
TJ950-0106	Motor Sheave Kit
TJ950-0104	Shaft Sheave Kit
TJ950-0151	2 HP Motor Kit
TJ950-0114	Drive Shaft Kit
TJ950-0108	Bearing Kit
TJ950-1074	Wheel Kit

**XL**

Product Code	Description
TJXL	Inducer Std 115V/60HZ/1725RPM/¾HP/10.8Amps
TJ950-6010	Wheel Kit (XL-R is Discontinued)
TJ950-0140	Can 3/4 HP Motor Kit (Also for Discontinued XL-R)

**ADDITIONAL PARTS**

Product Code	Description
TJPS-1505	Fan Proving Switch

Prices shown are based on carton quantities. 5% surcharge for broken cartons. Effective July 1st, 2023, our minimum Order Value before H.S.T. is \$250. Replacement parts not included. A surcharge of \$25 on all orders under this minimum will be applied. All prices are subject to change without notice.



## Confidential Distributors List Prices



TJERNLUND PRODUCTS, INC.

### SIDE WALL VENT SYSTEMS PARTS

#### GPAK-JT (GPAK-J & GPAK JT DISCONTINUED)

Product Code	Description
TJHSJ	Power Venter 24/115V Relay Includes UCI Control
TJ950-1020C	Motor Kit
TJ950-1010	Wheel Kit
TJ950-1030	Fan Prover with Sensing Tube Kit
TJ950-1067	1-10 Minute Adjustable Timer
TJ950-1040	24V/115V Vac Relay Kit

#### GPAK-IT (GPAK-I & IT DISCONTINUED)

Product Code	Description
TJHS1	Power Venter 24/115V Relay Includes UCI Control
TJ950-1020C	Motor Kit
TJ950-1011	Wheel Kit
TJ950-1030	Fan Prover with Sensing Tube Kit
TJ950-1067	1-10 Minute Adjustable Timer
TJ950-1040	24V/115V Vac Relay Kit

#### SS1C-U

Product Code	Description
TJSS1C-U	Power Venter Side Shot Includes UC1 Control
TJ950-0770	SS1C Plenum (Includes UC1)
TJ950-8804	UC1 Control Circuit Board
TJ950-1067	Adjustable 1-10 Min Timer/Relay (Pre UC1)
TJ950-0750	Fan Prover Kit
TJ950-0740	High Limit Switch
TJ950-0780	Terminus Switch
TJ950-0625	Motor/Wheel Assembly 5/8" Bore
TJ950-0635	Wheel 5/8" Bore
TJ950-0001	Sensing Tube with Inlet Collar
TJ950-0011	Terminus Cone with Brackets
TJ950-0641	Spring Ring Assembly

Prices shown are based on carton quantities. 5% surcharge for broken cartons. Effective July 1st, 2023, our minimum Order Value before H.S.T. is \$250. Replacement parts not included. A surcharge of \$25 on all orders under this minimum will be applied. All prices are subject to change without notice.



## Confidential Distributors List Prices



TJERNLUND PRODUCTS, INC.

### SIDE WALL VENT SYSTEMS PARTS

#### SS2 (SS2-G DISCONTINUED)

Product Code	Description
TJ950-8804	UC1 Control Circuit Board
TJ950-1067	Adjustable 1-10 Min Timer/Relay (Pre UC1)
TJ950-0016	Prover (Old Style External J Box Mount)
TJ950-0018	High Limit Switch
TJ950-0015	Motor Kit
TJ950-0017	Impeller (Stainless)
TJ950-0019	Venter Housing (Stainless)
TJ950-0020	Cooling Fan
TJ950-0099	Terminus Cabinet
TJ950-0029	Prover (External J Box Mount Since 07/02)

#### VP-2 (DISCONTINUED)

Product Code	Description
TJ950-2000	Housing/Wheel Kit
TJ950-2020	Motor Kit
TJ950-1067	Adjustable 1-10 Min Timer/Relay (Pre UC1)
TJ950-2030	24V/115V Transformer
TJ950-2050	6' Two Wire Spill Switch Cable (Old Style)
TJ950-2060	25' Three Wire Control Cable
TJ950-2070	Two 200° F Spill Switches (Old Style)
TJ950-2064	185° F Linear Limit Switch (New Style)
TJ950-2080	Gas Pressure Switch
TJ950-1070	Vibration Isolation Kit

#### SIDE WALL VENT HOODS

Product Code	Description
TJVH-1-3	3" Vent Hood with Casting
TJVH-1-4	4" Vent Hood with Casting
TJVH-1-6	6" Vent Hood
TJVH-1-8	8" Vent Hood
TJVH-1-10	10" Vent Hood

Prices shown are based on carton quantities. 5% surcharge for broken cartons. Effective July 1st, 2023, our minimum Order Value before H.S.T. is \$250. Replacement parts not included. A surcharge of \$25 on all orders under this minimum will be applied. All prices are subject to change without notice.



## Confidential Distributors List Prices



TJERNLUND PRODUCTS, INC.

### **POWER VENTER PARTS**

#### **HSJ (INCLUDES UC1 CONTROL) HSUL-J** **DISCONTINUED MODELS: HSUL-J, HST-J & HS115-J**

Product Code	Description
TJHSJ	Power Venter 24/115V Relay Includes UCI Control
TJ950-1020C	Motor Kit
TJ950-1010	Wheel Kit
TJ950-1030	Fan Prover with Sensing Tube Kit
TJ950-8804	UC1 Circuit Board (Only for HSJ)
TJ950-1040	Relay Kit (Only for HSUL-J)
TJ950-1067	Adjustable 1-10 Min Timer/Relay (Pre UC1) (Only for HST-J)

#### **HS1 (INCLUDES UC1 CONTROL)** **DISCONTINUED MODELS: HSUL-1, HST-1 & HST115-1**

Product Code	Description
TJHS1	Power Venter 24/115V Relay Includes UCI Control
TJ950-1020C	Motor Kit
TJ950-1011	Wheel Kit
TJ950-1030	Fan Prover with Sensing Tube Kit
TJ950-8804	UC1 Circuit Board (Only for HS1)
TJ950-1040	Relay Kit (Only for HSUL-1)
TJ950-1067	Adjustable 1-10 Min Timer/Relay (Pre UC1) (Only for HST-1)

#### **HS2 (INCLUDES UC1 CONTROL)** **DISCONTINUED MODELS: HSUL-2, HST-2 & HS115-2**

Product Code	Description
TJHS2	Power Venter 24/115V Relay Includes UCI Control
TJ950-1021C	Motor Kit with Wheel 3/8" Bore
TJ950-1012	Wheel Kit 3/8" Bore
TJ950-1031	Fan Prover with Sensing Tube Kit
TJ950-8804	UC1 Circuit Board (Only for HS2)
TJ950-1040	Relay Kit (Only for HSUL-2)
TJ950-1067	Adjustable 1-10 Min Timer/Relay (Pre UC1) (Only for HST-2 & HS115-2)

Prices shown are based on carton quantities. 5% surcharge for broken cartons. Effective July 1st, 2023, our minimum Order Value before H.S.T. is \$250. Replacement parts not included. A surcharge of \$25 on all orders under this minimum will be applied. All prices are subject to change without notice.



## Confidential Distributors List Prices



TJERNLUND PRODUCTS, INC.

# COMMERCIAL POWER VENTER PARTS

### HS3 (INCLUDES UC1 CONTROL)

Product Code	Description
TJHS3	Commercial Power Venter with UCI Control for Gas
TJ950-1022	1/4 HP Motor Kit
TJ950-1013	Wheel Kit
TJ950-1032	Fan Prover Kit
TJ950-1014	Housing
TJ950-8804	UC1 Circuit Board
TJ950-1040	Isolation or Motor Relay (Only Used for HS3 Models Prior to the UC1 Change Over Date 09/02)
TJ950-1046	Housing Sensing Tube Kit

### HS4 (INCLUDES UC1 CONTROL)

Product Code	Description
TJHS4	Commercial Power Venter with UCI Control for Gas
TJ950-1031C	1/3 HP Motor Kit
TJ950-1013	Wheel Kit
TJ950-0010	HS4 Shaft Extension
TJ950-1007	Fan Prover Kit
TJ950-1008	Housing
TJ950-8804	UC1 Circuit Board
TJ950-1040	Isolation or Motor Relay

### HS5 (INCLUDES UC1 CONTROL)

Product Code	Description
TJHS5	Commercial Power Venter with UCI Control for Gas
TJ950-1017	1 HP Motor Kit
TJ950-1015	Wheel Kit
TJ950-1007	Fan Prover Kit
TJ950-1018	Housing
TJ950-8804	UC1 Circuit Board
TJ950-1040	Isolation or Motor Relay

### SIDE WALL VENT SYSTEM

TJVP2F	Side Wall Vent System (For Water Heaters 60,000BTU or Less)
TJVP3F	Side Wall Vent System (For Water Heaters 60,000BTU to 120,000BTU)

Prices shown are based on carton quantities. 5% surcharge for broken cartons. Effective July 1st, 2023, our minimum Order Value before H.S.T. is \$250. Replacement parts not included. A surcharge of \$25 on all orders under this minimum will be applied. All prices are subject to change without notice.





## Confidential Distributors List Prices



TJERNLUND PRODUCTS, INC.

### DUCT BOOSTERS

#### TJ-DB-2

Product Code	Description
TJDB2	Duct Booster 1150RPM/70HP/200CFM Cap 5-8" Duct CSA Approved
TJ950-7010	Wheel Kit
TJ950-7025C	Motor Kit

#### TJ-EF-6

Product Code	Description
TJEF-6	Duct Fan for 6" Flex or Metal Duct

#### TJ-EF-8

Product Code	Description
TJEF-8	Duct Fan for 8" Flex or Metal Duct
TJ950-0428	Motor Kit
TJ950-0418	Impeller Kit

#### TH-EF-10

Product Code	Description
TJEF-10	IDDF for 10" Duct
TJ950-0425	Motor Kit
TJ950-0419	Impeller Kit

#### TJ-EF-12

Product Code	Description
TJEF-12	IDDF for 12" Duct
TJ950-0424	Motor Kit
TJ950-0420	Impeller Kit

#### TJ-EF-14

Product Code	Description
TJEF-14	IDDF for 14" Duct
TJ950-0423	Motor Kit
TJ950-0421	Impeller Kit

Prices shown are based on carton quantities. 5% surcharge for broken cartons. Effective July 1st, 2023, our minimum Order Value before H.S.T. is \$250. Replacement parts not included. A surcharge of \$25 on all orders under this minimum will be applied. All prices are subject to change without notice.



## Confidential Distributors List Prices



TJERNLUND PRODUCTS, INC.

# COMBUSTION AIR INTAKE EQUIPMENT PARTS

### TJ-PAI-1G

Product Code	Description
TJ950-3022C	Motor Kit
TJ950-0452	Fan Prover Kit
TJ950-1040	Relay Kit

### TJ-PAI-1G

Product Code	Description
TJ950-3022C	Motor Kit
TJ950-0452	Fan Prover Kit

# ACCESSORY CONTROL PARTS

### TJ-UC1

Product Code	Description
TJ950-8804	UC1 Circuit Board

### TJ-WHK-2

Product Code	Description
TJ950-1067	Adjustable 1-10 Min Timer/Relay (Pre UC1)
TJ950-2030	24V/115V Transformer
TJ950-2050	6' Two Wire Spill Switch Cable (Old Style)
TJ950-2060	25' Three Wire Control Cable
TJ950-2070	Two 200° F Spill Switches (Old Style)
TJ950-2064	185° F Linear Limit Switch (New Style)
TJ950-2080	Gas Pressure Switch

### TJ-WHK-1

Product Code	Description
TJ950-2075	One 200° F Spill Switches (Old Style)
TJ950-2064	185° F Linear Limit Switch (New Style)
TJ950-0501	Gas Pressure Switch
TJ950-0470	Thermocouple Junction Adapter

Prices shown are based on carton quantities. 5% surcharge for broken cartons. Effective July 1st, 2023, our minimum Order Value before H.S.T. is \$250. Replacement parts not included. A surcharge of \$25 on all orders under this minimum will be applied. All prices are subject to change without notice.

**Confidential Distributors List Prices**



**SOOTMASTERS**

**641M**

Product Code	Description
MT641M	3.5 Gallon 1HP Motor
MT4464S	Replacement Bags for Model 641M

**652M**

Product Code	Description
MT652M	5 Gallon 1HP Motor
MT4465	Replacement Bags for Model 652M

**SOOTMASTER PARTS**

Product Code	Description
MTCV46A	Clog Proof Dacron Bag for 14" Dia Vacuum
MTCV47	Clog Proof Dacron Bag for 16" Dia Vacuum
MT2T1	Tie Cord for Standard or Deluxe Open Top Bags
MT7HB-3	Rubber Stretch Hose 6-16' c/w Rubber Cuffs
MT7HB-7	10' White Duck - Rubber Lined Hose
MT7HB-9	10' Black Canvas - Rubber Lined Hose
MT7HB-17E	10' Vinyl Hose with Molded Vinyl Cuffs
MT7HB-21AB-10	10' Crushproof Vinyl Hose 1 1/2" ID

**641M  
DRY ONLY**



**652M  
DRY ONLY**



Prices shown are based on carton quantities. 5% surcharge for broken cartons. Effective July 1st, 2023, our minimum Order Value before H.S.T. is \$250. Replacement parts not included. A surcharge of \$25 on all orders under this minimum will be applied. All prices are subject to change without notice.



## Confidential Distributors List Prices

**MASTERCRAFT**  
PROFESSIONAL PRODUCTS FOR A CLEANER ENVIRONMENT

### MORE SOOTMASTERS PARTS

Product Code	Description
MT100-2	5' Aluminum Double Bend Curved Wand
MT103-1	15" Metal Crevice Tool
MT103-2	27" Metal Crevice Tool
MT103-5	11" Plastic Crevice Tool
MT103-7	6' x 1 1/2" OD Flexible Metal Hose
MT103-9	Blower Nozzle
MT103-10	6' x 1" OD Flexible Metal Hose
MT103-11	4' x 7/8" Flex Metal Hose
MT104-11	6" Utility Nozzle Tapered Fit
MT105-1	Metal Connector Adjoins Two 1 1/2" ID Hoses
MT106-1	12" Wide Mouth Gulper Nozzle
MT1015	Filter Frame Assembly 16" Diameter
MT1016	Filter Frame Assembly 14" Diameter
MT1017	Filter Frame Assembly 14" Diameter Pancake Style
MT1126	Cloth Filter & Gasket 14" Diameter Pancake Style
MT1127	Cloth Filter & Gasket 14" Diameter
MT1128	Cloth Filter & Gasket 16" Diameter
MT1203	Replacement Toggle Switch
MT12541	2 1/2" Diameter Non Marking Swivel Caster
MT1455	1 1/2" Swivel Connector for Vacuum
MT1668	Rubber Sealing Gasket for 1455
MT1700	Hose Cage for 14" Diameter Cans
MT2797	Replacement Blower Outlet
MT4464S	Paper Filter Bags 5 Pack for Model 641M
MT4465	Paper Filter Bags 5 Pack for Model 654M & 653M
MT4562PL	Totally Enclosed 16" Bags 5 Pack for Models 654M/661M
MT5041	1 HP Air Cooled Motor
MTDA1515	Drum Adapter 2 1/4 HP Wet/Dry
MT5520Z220	Canister Assembly for 641M Vacuum
MT5522Z202	Head Assembly for 641M Vacuum
MT5521Z201	Dome Assembly for 641M Vacuum
MT410SSDAF	Back Pack HEPA Vacuum 1 1/4 HP
MT261416	4' x 7/8" Flexible Metal Hose

Prices shown are based on carton quantities. 5% surcharge for broken cartons. Effective July 1st, 2023, our minimum Order Value before H.S.T. is \$250. Replacement parts not included. A surcharge of \$25 on all orders under this minimum will be applied. All prices are subject to change without notice.



**Confidential Distributors List Prices**



**SUPERIOR SMOKE GENERATORS**

Product Code	Description
SU1A	30 Second /4000 Cubic Feet 1 ½” x 1 Smoke Generator
SU2B	1 Minute / 8000 Cubic Feet 1 ½” x 2” Smoke Generator
SU3C	2 – 3 Minute / 40,000 Cubic Feet 1 ½” x 6” Smoke Generator



**SU2B Smoke Generator**

Prices shown are based on carton quantities. 5% surcharge for broken cartons. Effective July 1st, 2023, our minimum Order Value before H.S.T. is \$250. Replacement parts not included. A surcharge of \$25 on all orders under this minimum will be applied. All prices are subject to change without notice.



## Standard Terms and Conditions

### PRICING

All standard pricing is based on our current Distributor Price List Schedules, which is updated & distributed as required. Every effort is made to provide a minimum 30-day notification of a price change, however CGF reserves the right to change prices without notification.

SEASONAL STOCKING PROMOTIONS: CGF periodically issues stocking programs at special discounted net prices and terms. Refer to the program for specific details.

SPECIAL PRICE QUOTATIONS: If special price quotes are issued by CGF, a valid quote number must be shown on all related purchase orders. A valid quote will show validation date and expiry date, as well as part number, quantities, and terms. Quotes must be written and signed by a Canadian General Filters Ltd signing officer.

SURCHARGE, BROKEN CARTONS: A 5% surcharge will be charged if the quantity of goods ordered result in a broken carton. This surcharge is enforced in all circumstances, regardless whether the product pricing is regular, part of a seasonal promotion or specifically quoted.

### ORDERING

Effective July 1st, 2023, our minimum Order Value before H.S.T. is \$250. A surcharge of \$25 on all orders under this minimum will be applied. Replacement parts not included.

Customer Service is available by phone from 8:00am to 4:30pm EST Monday to Friday at 416-757-3691 or toll free at 1-888-216-9184. To minimize possible errors or miscommunication, we require that all purchase orders be faxed to CGF Products at 416-757-4687 or emailed to sales@generalaireiaq.ca

ACKNOWLEDGEMENTS: All orders will be acknowledged by fax or email. It is the customers responsibility to advise of any changes or adjustments to the order as acknowledged.

### FREIGHT TERMS

Unless otherwise specified, all shipments are FOB CGF's Midwest warehouse.  
FREIGHT POLICY CHANGE effective **April 1st 2024**

PREPAID FREIGHT: Filter cabinets & Filter media do not qualify for pre-paid freight! To qualify for Prepaid Freight, all orders for products that qualify must total or exceed \$5,000.00 net (before taxes). To be more specific, the products not eligible for Prepaid Freight are: Air Filters, Air Cleaner Cabinets & Perfect Platforms. Customers can continue to submit orders inclusive of the excluded items and CGF staff will remove the non-eligible items & create a separate release. CGF will supply the information required for customers to organize their own transportation for non-eligible items. CGF offers a 2% freight allowance on the bottom of the invoice for non-eligible pre-paid products.

#### SPECIFIC LIST OF INELIGIBLE PREPAID ITEMS:

GFMAC2000-11, GFMAC1400-11, GFMAC1200, GFMAC2020-11, GFMACL, GF1625-11, GF2025-11, GFGAFB2832-11, GFGAFB2843-11, GF4551, GF4541, GF4521, GF4556, GF4557, GF4366, GF4367, GF4368 and 6" furnace base models SF1728G, SF2128G, SF2428G



---



---

## Standard Terms and Conditions

### CREDIT TERMS

Standard credit terms for approved accounts are 1 ½ % 10, net 30 days.

DISCOUNTS APPLIED: Cash discounts for early payment are to be taken on the invoiced product value excluding freight and taxes

UNEARNED DISCOUNTS: To be eligible for cash discounts, accounts must be current and payment must be received by CGF Ltd no later than the discount due date. Unearned discounts taken will not be honored by CGF.

OUTSTANDING ACCOUNTS: If an account is past due, shipment of new orders will be held. Upon receipt of payment, shipments will be released accordingly.

CREDIT NOTES: With the exception of early payment discounts, customers are not entitled to make any deductions from payments without CGF authorization in the form of a Credit Note. We reserve the right to inspect and assess the product to determine applicable re-stocking charges, before issuing Credit Notes.

Goods returned for credit will be subject to a minimum restocking charge of 35%.

### WARRANTY

Canadian General Filters Limited will warranty items upon review of our warranty coverage chart and purchase invoice.

The warranty covers product defects in materials and workmanship only. Defective parts will be repaired or replaced at the manufacturer's discretion without charge. Costs involved in the removal, re-installation and/or transportation of the defective part is not covered by warranty.

There are no express warranties other than those set forth above, the implied warranties of merchant ability and fitness for a particular purpose are limited in duration to one year. The manufacturer assumes no liability in connection with the installation or use of the products except as stated in this limited warranty.

The manufacturer assumes no responsibility and will not be held liable for incidental or consequential damages.

This warranty does not cover labour charges, failure due to abuse, improper use, normal wear and tear or consumables.

### RETURN OF GOODS POLICY

ALL GOODS RETURNED: Whatever the reason, must have a Returned Goods Authorization (RGA) Number issued by our Customer Service Department, and must be returned within 14 days of issue of this RGA number. RGA must be clearly displayed on outside of package. All returned goods will be shipped prepaid unless otherwise approved and the paperwork must indicate the RGA number.

Goods returned for credit must be in the original packaging and must be in new saleable condition. All goods returned for credit are subject to inspection and acceptance by CGF and are subject to a minimum restocking charge of 35%. Additional charges may apply. CGF reserves the right to refuse returned goods due to age and condition of the products.

### DAMAGED GOODS

If the shipment is prepaid, Canadian General Filters is responsible for carrier damages/shortages. An investigation with the transport company is then initiated

Non-prepaid or pick up shipments are not the responsibility of Canadian General Filters, customer must deal with the transport company directly for any damages/shortages.

Title to goods shipped via common carrier collect passes to the consignee upon acceptance of the shipment by the carrier. All claims for loss, due to shortage or damage, must be made to the Transportation company. Upon discovery of concealed damage, or shortage, notify the carrier agent at once and request an inspection.

All shortages must be reported within 24 – 48 hours of receipt of shipment for credits to be honored